

# MOBILE MINING EQUIPMENT

HYDRAULIC SEALING SOLUTIONS



A large-scale open-pit mine is shown, characterized by its terraced, stepped rock walls. The mine is filled with various shades of brown, tan, and grey, indicating different geological layers. In the foreground, a worker wearing a white hard hat and a high-visibility yellow safety vest is seen from the side, looking through a surveying instrument mounted on a tripod. The background shows the vast expanse of the mine, with winding roads and some yellow machinery visible on the different levels. The sky is bright and slightly hazy.

**Today's environment has created many unique challenges for the mining industry, such as:**

- System Availability
- Equipment Productivity
- Capacity Throughput
- Operational Efficiencies
- Asset Management
- Safety Compliance
- Environmental Policies
- Sustainable Practices
- Digital Transformation

# Solutions

## Increased reliability and reduced costs

We know that mining is a challenging business and to help reduce the cost of downtime, you must meet critical challenges and anticipate the unexpected every day. Whether you're in the metal, mineral, or coal mining markets, we can help you manage costs and maintain margins by optimizing the value of your equipment investments.

Chesterton® sealing solutions help increase cylinder reliability by extending the hours of operation between maintenance intervals. Our turnkey cylinder repair kits combine proprietary polymer technologies with unique seal geometries to help improve the performance of your off-road mining equipment.

Enhanced sealing solutions for mining equipment not only increase meant time between failure but also lead to significant oil savings. This dual benefit not only helps reduce our carbon footprint but also enhances our sustainable environmental impact.



**Chesterton is uniquely positioned, with decades of know-how and experience, to help you drive significant improvements in equipment reliability.**

### Our comprehensive services include:

- Turnkey custom cylinder repair kits
- Skilled in-field technical support
- On-site inspection and troubleshooting
- Experienced application engineers and designers
- Proven approach towards cylinder upgrades

# Value-driven Approach

## Our Product, Service, and Technical Expertise

Real world proof comes from the performance of Chesterton products in various applications used in mine after mine worldwide. The cost of a replacement seal kit is the least expensive aspect of a cylinder rebuild yet can have the greatest impact on production. Protect your assets while increasing your productivity and efficiency by upgrading to Chesterton products.

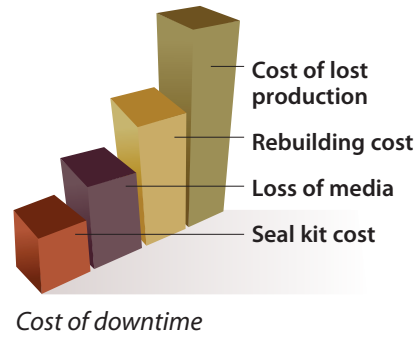

## Turnkey Custom Cylinder Kits

The rigors of surface mining are well-known. Whether it's corrosion, contamination, side loading, or shock loading conditions, these challenging environments and destructive loads take their toll on your equipment. To help protect your assets and lower overall cost of ownership, Chesterton provides high performance, turnkey cylinder repair kits proven to perform under these conditions.

- **Excavators (shovel and backhoe)**  
Boom, arm bucket, dump, and level cylinder kits
- **Trucks**  
Hoist, front and rear suspension, steering cylinder kits
- **Wheel loaders**  
Lift, steering, and tilt cylinder kits
- **Dozers**  
Tilt, lift, ripper tilt, and ripper lifter cylinder kits



## Experienced Field Specialists

Chesterton's skilled field specialists work in collaboration with customers to understand their needs and provide the best solution for their application. Our local service is supported by a global distribution and logistics network that enables us to reach and react to the shifting needs of mining customers around the world.

- Knowledgeable field specialists on-site
- Hands-on equipment analysis
- Kits stocked and serviced locally
- Exceptional customer service
- Global distribution network

## Engineering Support

Chesterton has decades of combined engineering experience in the mining industry. Our engineers focus on developing unique solutions that solve mining's most difficult sealing challenges. These polymer sealing experts develop proven solutions from comparable situations that help improve equipment reliability.

- Engineer-to-engineer collaboration
- Expert applications engineering support
- Application-specific solutions
- Experienced seal design experts

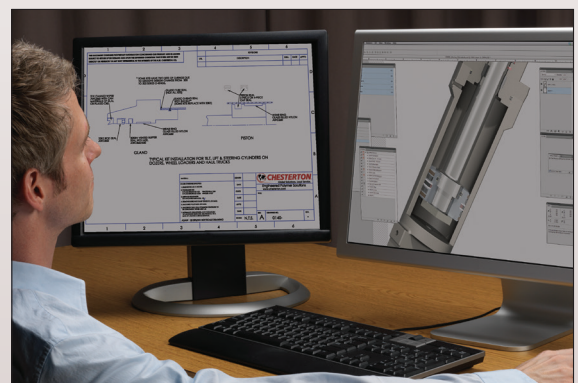

# Sealing Technology

## Cylinder Upgrades

### *Solutions Approach*

THE CHESTERTON CYLINDER UPGRADE PROGRAM applies a systematic solutions approach for improving seal performance during the repair and overhaul of equipment. Working in partnership with you, we offer a unique approach to total cylinder re-fitting that saves money and delivers a better, more reliable cylinder back to the mine.

- Address environmental issues
- Improve equipment reliability
- Extend leak-free service life
- Reduce hydraulic oil consumption
- Minimize downtime and maintenance costs

## Materials

### *Unique Thermoset Polyurethane*

Chesterton's proprietary polymer technologies offer high abrasion and cut resistance designed to withstand the elements and extend the hours of equipment operation between maintenance intervals. Whether extreme heat or cold, our exclusive thermoset materials allow your equipment to run longer, thereby helping to improve equipment performance and reliability.

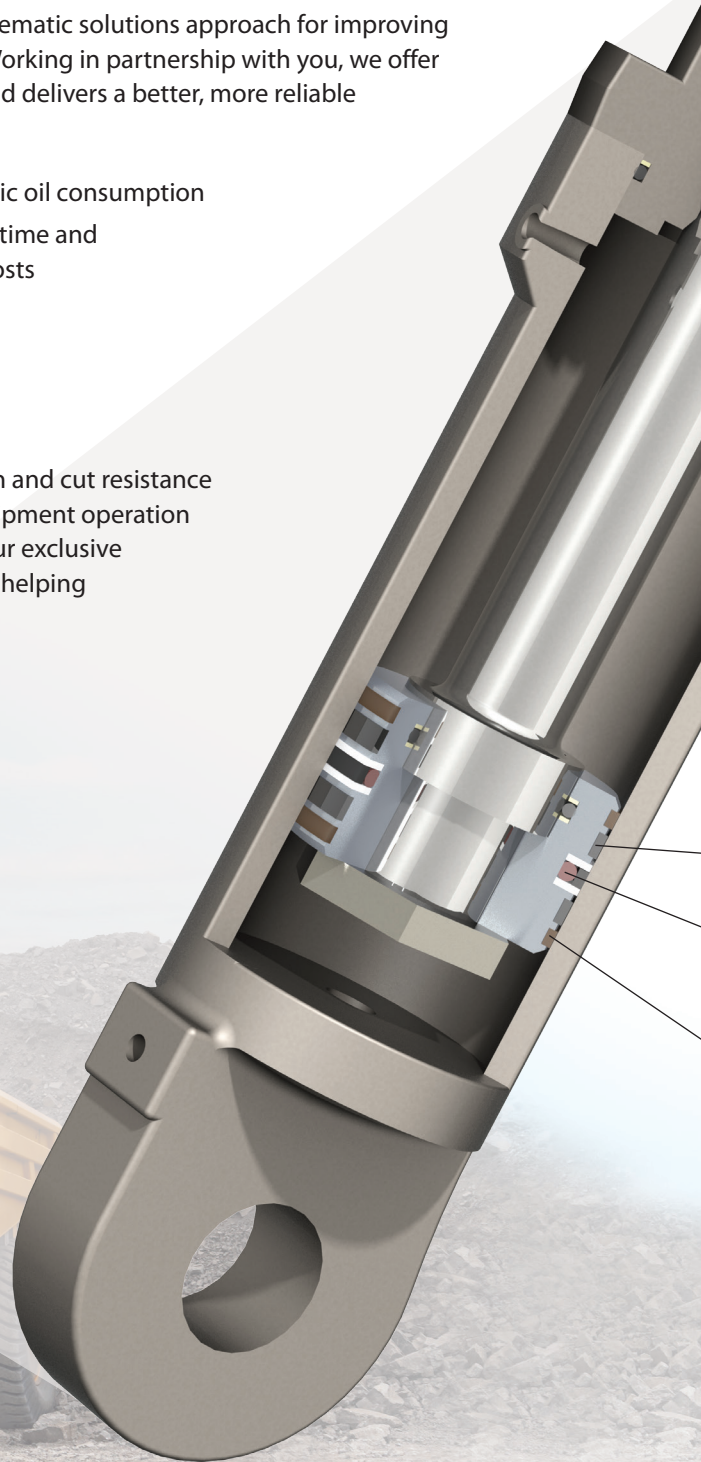

## Designs

### Custom Seals and Components

Chesterton offers a wide range of seal profiles specifically designed for the mining industry. These sealing solutions were designed to accommodate a broad range of cylinders used on mobile mining equipment.

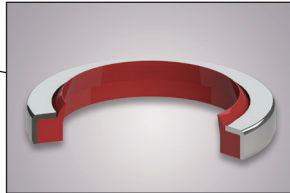
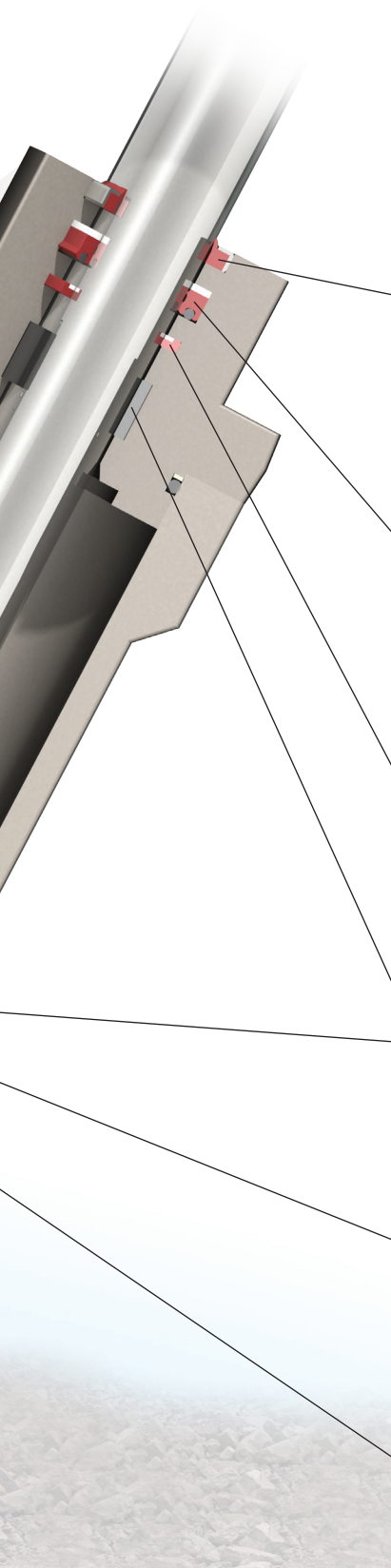

#### Wiper

##### *Minimizes contaminants from entering the system*

Our stainless steel canned wiper design effectively dislodges foreign material from the retracting rod which keeps external contaminants from entering the system, thus helping to minimize expensive gland replacements.

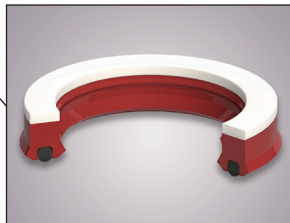

#### Rod Seal

##### *Combats low pressure leakage*

Unique heavy-duty, custom rod seal provides increased pre-loads to minimize issues associated with low pressure leakage while also providing added stability at higher pressures and temperatures.

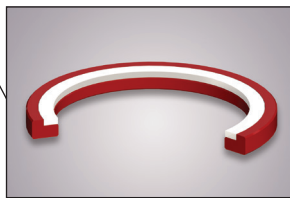

#### Buffer Seal

##### *Reduces impact of pressure spikes*

Our buffer seal is designed to reduce the impact of pressure spikes on the primary seal while the custom vented slots minimize the possibility of pressure trapping between itself and the rod seal.



#### Precision Bearing Band

##### *Minimizes metal-to-metal contact*

These precision split bearing bands offer the same carrying load as bronze and, when used in combination with our sealing devices, have proven to be the ideal choice to optimize cylinder life.



#### Piston Seal

##### *Bi-directional sealing system*

This four-piece, bi-directional sealing system creates a very effective seal through the entire operating range even when exposed to tremendous pressure spikes.

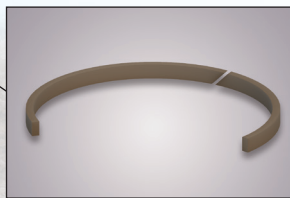

#### Trash Ring

##### *Absorbs contaminants within the fluid*

This ancillary device functions as the first line of defense for piston seals and bearing bands by absorbing contaminants in the system, thus helping to protect the sealing components and extend maintenance intervals.

# Speed of Service

## Industry Leading Materials and Advanced Designs

Chesterton is a technology leader in the polymer seal industry. Our SpeedSeal™ capability brings same-day service of this advanced technology to customers worldwide. Strategically located and integrated service centers use innovative



manufacturing methods to provide you with a broad selection of proven designs and a wide range of high performance materials.

This capability is supported by a network of highly trained and experienced Field Specialists and Application Engineers who offer the best service and applications assistance in the industry.

- Same day delivery
- Experienced field service
- Engineering expertise
- Sizes to 1370 mm (54")
- On-hand inventory
- Custom designs
- Exclusive Chesterton materials
- Kits stocked and serviced locally

### Our service center locations:



## Global Solutions, Local Service

Since its founding in 1884, the A.W. Chesterton Company has successfully met the critical needs of its diverse customer base. Today, as always, customers count on Chesterton solutions to increase equipment reliability, optimize energy consumption, and provide local technical support and service wherever they are in the world.

Chesterton's global capabilities include:

- Servicing plants in over 113 countries
- Global manufacturing operations
- More than 500 Service Centers and Sales Offices worldwide
- Over 1200 trained local Service Specialists and Technicians

Visit our website at [chesterton.com](http://chesterton.com)



Chesterton ISO certificates available on [chesterton.com/corporate/iso](http://chesterton.com/corporate/iso)

Distributed by:

SpeedSeal™ is a trademark of A.W. Chesterton Company. Technical data reflects results of laboratory tests and is intended to indicate general characteristics only. A.W. Chesterton Company disclaims all warranties express or implied, including warranties of merchantability and fitness for a particular purpose. Liability, if any, is limited to product replacement only. Any images contained herein are for general illustrative or aesthetic purposes only and are not intended to convey any instructional, safety, handling or usage information or advice respecting any product or equipment. Please refer to relevant Safety Data Sheets, Product Data Sheets, and/or Product Labels for safe use, storage, handling, and disposal of products, or consult with your local Chesterton sales representative.

© 2024 A.W. Chesterton Company.

® Registered trademark owned by A.W. Chesterton Company in USA and other countries, unless otherwise noted.



A.W. Chesterton Company  
860 Salem Street  
Groveland, MA 01834 USA

Telephone: 781-438-7000  
[chesterton.com](http://chesterton.com)

Form No. EN23281  
Mobile Mining Equipment  
Brochure – English  
05/24